

TEST REPORT
on behalf of
Yueqing City Gudu Electric Co.,Ltd
Switching Power Supply

Prepared For: Yueqing City Gudu Electric Co.,Ltd
Fangdouyan Village, Liushi Town, Yueqing City, Zhejiang Province,
China.

Prepared By: Shanghai Global Testing Services Co., Ltd.
No. 968 Meilong West Road, Minhang District, Shanghai, 201104
China.

Report No.: TEZJ18040213697
Date of Test: April 02, 2018 to April 09, 2018
Date of Report: April 09, 2018

EN 55032:2015 EN 55035:2017
 EN 61000-3-2:2014
 EN 61000-3-3:2013

EMC MEASUREMENT AND TEST REPORT

FOR

Yueqing City Gudu Electric Co.,Ltd

Fangdouyan Village, Liushi Town, Yueqing City, Zhejiang Province, China.

Name Of Sample..	Switching Power Supply
Model.....	S-15——S-2000, LRS-35——LRS-350, DR-30——DR-240, FY-40——FY-350,FS-10——FS-200,NES-15——NES-350, MS-15——MS-150, D-30——D-120, T-30——T-120, Q-60——Q-120,SD-25——SD-500
Ratings.....	/
Date of Receipt...	2018-04-02
Date of Test.....	2018-04-02 to 2018-04-09
Test Engineer.....	Sophia Yu
Reviewed By.....	Linda lin
Approved By.....	Cristine Fang
<p>* The above equipment was tested by Shanghai Global Testing Services Co., Ltd. for compliance with the requirements set forth in the EMC Directive 2014/30/EU and the technical standards mentioned above. The results of testing in this report apply only to the product/system, which was tested. Other similar equipment will not necessarily produce the same results due to production tolerance and measurement uncertainties.</p>	



Test Result	PASS
--------------------	-------------

Note: This report shall not be reproduced except in full, without the written approval of **Shanghai Global Testing Services Co., Ltd.** This document may be altered or revised by **Shanghai Global Testing Services Co., Ltd.** personnel only, and shall be noted in the revision section of the document.

TABLE OF CONTENTS

GENERAL INFORMATION4

PRODUCT DESCRIPTION FOR EQUIPMENT UNDER TEST (EUT)4

OBJECTIVE.....4

EQUIPMENT MODIFICATIONS4

1 - EN61000-3-2: 20145

1.1 TEST EQUIPMENT LIST AND DETAILS5

1.2 LIMITS.....5

1.3 TEST PROCEDURE AND THE TEST SET-UP.....5

1.4 TEST DATA AND RECORDS6

1.5 VERDICT6

2 - EN61000-3-3: 2013.....7

2.1 TEST EQUIPMENT LIST AND DETAILS7

2.2 LIMITS.....7

2.3 TEST PROCEDURE AND THE TEST SET-UP.....7

2.4 TEST DATA AND RECORDS8

2.5 VERDICT8

3 – EN 550329

3.1 CONDUCTED DISTURBANCE AT THE MAINS TERMINALS.....9

3.1.1 TEST EQUIPMENT LIST AND DETAILS9

3.1.2 DESCRIPTION OF MEASUREMENT CONDITIONS9

3.1.3 LIMITS FOR CONDUCTED DISTURBANCE AT THE MAINS TERMINAL OF CLASS B ITE.....9

3.1.4 TEST PROCEDURE AND THE TEST SET-UP.....10

3.1.5 TEST DATA AND RECORDS10

3.1.6 VERDICT10

3.2 CONDUCTED DISTURBANCE AT TELECOMMUNICATION PORTS.....11

3.2.1 TEST EQUIPMENT LIST AND DETAILS11

3.2.2 DESCRIPTION OF MEASUREMENT CONDITIONS11

3.2.3 LIMITS FOR CONDUCTED DISTURBANCE AT THE MAINS TERMINAL OF CLASS B ITE.....11

3.2.4 CONFIGURATION.....11

3.2.5 TEST DATA AND RECORDS11

3.2.6 VERDICT11

3.3 RADIATION DISTURBANCES12

3.3.1 TEST EQUIPMENT LIST AND DETAILS12

3.3.2 DESCRIPTION OF MEASUREMENT CONDITIONS12

3.3.3 LIMITS OF RADIATED DISTURBANCES OF CLASS B ITE AT A MEASURING DISTANCE OF 3M.....12

3.3.4 TEST PROCEDURE AND THE TEST SET-UP.....12

3.3.5 TEST DATA AND RECORDS13

3.3.6 VERDICT THE EUT MET THE REQUIREMENT13

4 –EN5503514

DESCRIPTION OF PERFORMANCE CRITERION (ACCORDING WITH EN55024 SECTION 7.1)14

4.1 SURGES15

4.1.1 TEST EQUIPMENT LIST AND DETAILS15

4.1.2 DESCRIPTION OF MEASUREMENT CONDITIONS15

4.1.3 CONFIGURATION.....15

4.1.4 TEST DATA AND RECORDS15

4.1.5 VERDICT15

4.2 ESD16

4.2.1 TEST EQUIPMENT LIST AND DETAILS16

4.2.2 DESCRIPTION OF MEASUREMENT CONDITIONS16

4.2.3 CONFIGURATION.....16

4.2.4 TEST DATA AND RECORDS16

4.2.5 VERDICT17

4.3 EFT/B18

Note: This report shall not be reproduced except in full, without the written approval of **Shanghai Global Testing Services Co., Ltd.** This document may be altered or revised by **Shanghai Global Testing Services Co., Ltd.** personnel only, and shall be noted in the revision section of the document.

4.3.1 TEST EQUIPMENT LIST AND DETAILS	18
4.3.2 DESCRIPTION OF MEASUREMENT CONDITIONS	18
4.3.3 CONFIGURATION.....	18
4.3.4 TEST DATA AND RECORDS	18
4.3.5 VERDICT	18
4.4 RADIO-FREQUENCY CONTINUOUS CONDUCTED, 0.15 MHZ TO 80 MHZ	19
4.4.1 TEST EQUIPMENT LIST AND DETAILS	19
4.4.2 DESCRIPTION OF MEASUREMENT CONDITIONS	19
4.4.3 CONFIGURATION.....	19
4.4.4 TEST DATA AND RECORDS	19
4.4.5 VERDICT	19
4.5 VOLTAGE DIPS AND INTERRUPTIONS.....	20
4.5.1 TEST EQUIPMENT LIST AND DETAILS	20
4.5.2 DESCRIPTION OF MEASUREMENT CONDITIONS	20
4.5.3 CONFIGURATION.....	20
4.5.4 TEST DATA AND RECORDS	20
4.5.5 VERDICT	20
4.6 RADIO-FREQUENCY ELECTROMAGNETIC FIELD	21
4.6.1 TEST EQUIPMENT LIST AND DETAILS	21
4.6.2 DESCRIPTION OF MEASUREMENT CONDITIONS	21
4.6.3 CONFIGURATION.....	21
4.6.4 TEST DATA AND RECORDS	21
4.6.5 VERDICT	21
4.7 POWER-FREQUENCY MAGNETIC FIELD	22
4.7.1 TEST EQUIPMENT LIST AND DETAILS	22
4.7.2 DESCRIPTION OF MEASUREMENT CONDITIONS	22
4.7.3 CONFIGURATION.....	22
4.7.3 TEST DATA AND RECORDS	22
4.7.4 VERDICT	22
APPENDIX —PHOTOGRAPH	23

GENERAL INFORMATION

Product Description for Equipment Under Test (EUT)

The product that is produced by **Yueqing City Gudu Electric Co.,Ltd** test model: **S-350-24**. The "EUT" as referred to in this report is a **Switching Power Supply**.

Complete test was conducted on Switch Power.

Objective

In order to meet the EMC requirements approved by CENELEC, the following standards will be cited:

1. EN 61000-3-2:2014, EMC-Limits-Limits for the harmonic current emissions (equipment input current up to and including 16 A per phase).
2. EN 61000-3-3:2013 , EMC-Limits-Limitation of voltage changes, voltage fluctuations and flicker in public low-voltage supply systems, for equipment with rated current ≤ 16 A per phase and not subject to conditional connection.
3. EN 55032:2015 Information technology equipment-Radio disturbance characteristics- Limits and methods of measurement.
4. EN 55035:2017 Electromagnetic compatibility of multimedia equipment – Immunity Requirements

The objective of the manufacturer is to demonstrate compliance with the limits for Information Technology Equipment -Limits and methods of measurement.

Note: The test data is only valid for the test sample. There is possible deviation from the original test data for other products

Equipment Modifications

No modification to the EUT was made by **Shanghai Global Testing Services Co., Ltd** to make sure the EUT comply with applicable limits.

Note: This report shall not be reproduced except in full, without the written approval of **Shanghai Global Testing Services Co., Ltd**. This document may be altered or revised by **Shanghai Global Testing Services Co., Ltd** personnel only, and shall be noted in the revision section of the document.

1 - EN61000-3-2: 2014

1.1 Test Equipment List and Details

Item	Test Equipment	Manufacturer	Model No.	Series No.	Cal. Date	Cal. Due date
1	Single phase harmonics&flicker analyzer	EM test	DPA500	V050710905	2017-12-03	2018-12-02
2	AC SOURCE 6KVA	EM test	ACS500	V050710405	2017-12-03	2018-12-02

1.2 Limits

Limits for Class A equipment

Harmonic order n	Maximum permissible harmonic current A
Odd harmonics	
3	2,30
5	1,14
7	0,77
9	0,40
11	0,33
13	0,21
$15 \leq n \leq 39$	$0,15 \frac{15}{n}$
Even harmonics	
2	1,08
4	0,43
6	0,30
$8 \leq n \leq 40$	$0,23 \frac{8}{n}$

1.3 Test procedure and the test set-up

Procedure

- a. The EUT was placed on the top of a wooden table 0.8 meters above the ground and operated to produce the maximum harmonic components under normal operating conditions for each successive harmonic component in turn.
- b. The classification of EUT is according to section 5 of EN 61000-3-2. The EUT is classified as follows:
 - Class A: Balanced three-phase equipment, Household appliances excluding equipment as Class D, Tools excluding portable tools, Dimmers for incandescent lamps, audio equipment, equipment not specified in one of the three other classes.
 - Class B: Portable tools. Arc welding equipment which is not professional equipment
 - Class C: Lighting equipment, including dimming devices.
 - Class D: Equipment having a specified power less than or equal to 600 W of the following types: Personal computers and personal computer monitors.
- c. The correspondent test program of test instrument to measure the current harmonics emanated from EUT is chosen. The measure time shall be not less than the time necessary for the EUT to be exercised.

Set-up

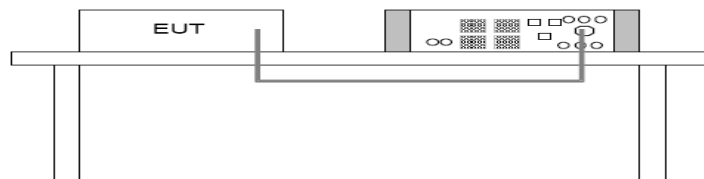

Note: This report shall not be reproduced except in full, without the written approval of **Shanghai Global Testing Services Co., Ltd.** This document may be altered or revised by **Shanghai Global Testing Services Co., Ltd.** personnel only, and shall be noted in the revision section of the document.

1.4 Test Data and Records

Test case does not apply to the test object (<75W)

1.5 Verdict

The EUT met the requirement.

2 - EN61000-3-3: 2013

2.1 Test Equipment List and Details

Item	Test Equipment	Manufacturer	Model No.	Series No.	Cal. Date	Cal. Due date
1	Single phase harmonics&flicker analyzer	EM test	DPA500	V050710905	2017-12-03	2018-12-02
2	AC SOURCE 6KVA	EM test	ACS500	V050710405	2017-12-03	2018-12-02

2.2 Limits

- The value of Pst shall not be greater than 1.0;
- The value of Plt shall not be greater than 0.65;
- The value of $d(t)$ during a voltage change shall not exceed 3.3% for more than 500ms;
- The relative steady-state voltage change, dc , shall not exceed 3.3%;
- The maxim relative voltage change, $dmax$, shall not exceed 4%.

Notes:

Pst : Short-term flicker indicator The flicker severity evaluated over a short period (in minutes); $Pst=1$ is the conventional threshold of irritability;

Plt : long-term flicker indicator; the flicker severity evaluated over a long period (a few hours) Using successive Pst values;

dc : the relative steady-state voltage change ;

$dmax$: maximum relative voltage change ;

$d(t)$: the value during a voltage change .

2.3 Test procedure and the test set-up

Procedure

- a. The EUT was placed on the top of a wooden table 0.8 meters above the ground and operated to produce the most unfavorable sequence of voltage changes under normal operating conditions.
- b. During the flick measurement, the measure time shall include that part of whole operation cycle in which the EUT produce the most unfavorable sequence of voltage changes. The observation period for short-term flicker indicator is 10 minutes and the observation period for long-term flicker indicator is 2 hours.

Set-up

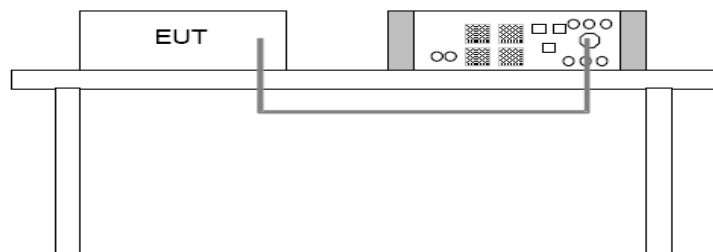

Note: This report shall not be reproduced except in full, without the written approval of **Shanghai Global Testing Services Co., Ltd.** This document may be altered or revised by **Shanghai Global Testing Services Co., Ltd.** personnel only, and shall be noted in the revision section of the document.

2.4 Test Data and Records

Flicker	Limit	Value
Short-term flicker Indicator Pst	1.0	0.273
Long -term flicker Indicator Plt	0.65	0.128

Voltage fluctuation	Limit	Value
Relative voltage change characteristic(dt)	500ms	0
Max relative voltage change characteristic(dmax)	6%	0.235%

Result: PASSED

2.5 Verdict

The EUT met the requirement.

3 - EN55032

3.1 Conducted disturbance at the Mains Terminals.

3.1.1 Test Equipment List and Details

Item	Test Equipment	Manufacturer	Model No.	Serial No.	Cal. Date	Cal. Due date
1	EMI test receiver	Rohde & Schwarz	ESCS25	1005426	2017-12-03	2018-12-02
2	Line impedance stabilization network	SCHWARZBECK	NSLK838	8127-350	2017-12-03	2018-12-02

3.1.2 Description of Measurement Conditions

Temperature: 21 °C

Humidity: 58%

Pressure: 1033mbar

Electromagnetic environment: normal

3.1.3 Limits for conducted disturbance at the mains terminal of class B ITE

Frequency range MHz	Limit values dB(μV)	
	Quasi-peak	Average
0.15 to 0.5	66~56	56~46
0.5 to 5	56	46
5 to 30	60	50

NOTE 1: The lower limit shall apply at the transition frequencies.
NOTE 2: The limit decreases linearly with the frequency in the range 0,15 MHz to 0,50 MHz.

3.1.4 Test procedure and the test set-up

The configuration is in accordance with the requirement in EN55022, the sketch map as follow:

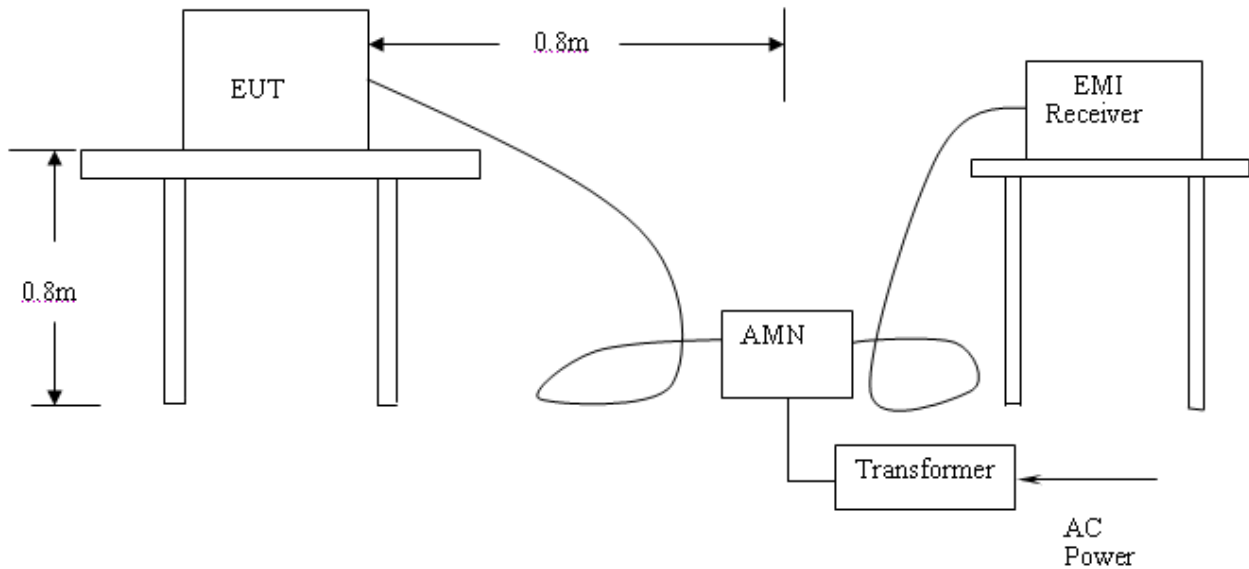

3.1.5 Test Data and Records

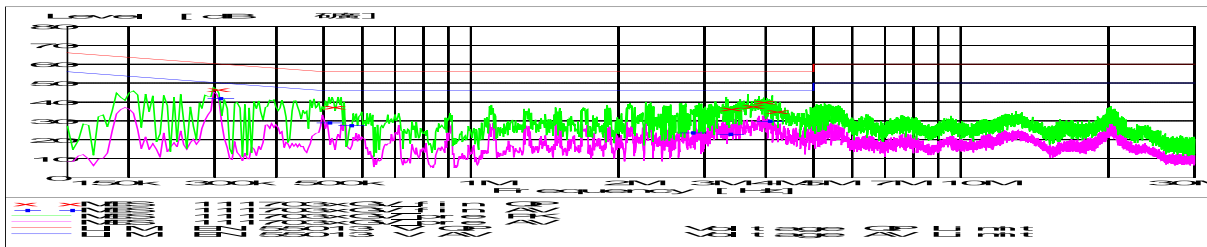
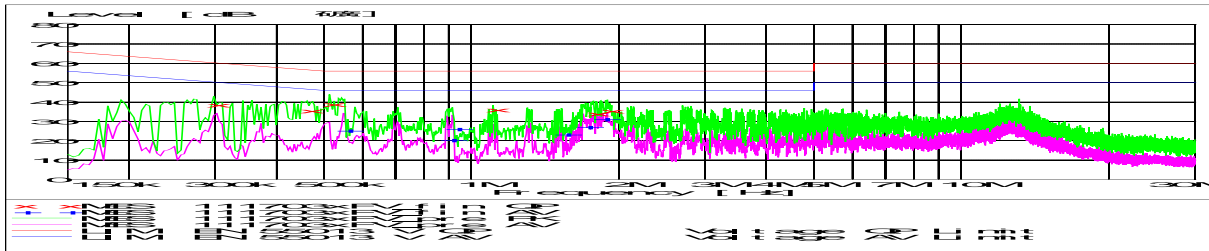

3.1.6 Verdict

The EUT met the requirement.

Note: This report shall not be reproduced except in full, without the written approval of **Shanghai Global Testing Services Co., Ltd.** This document may be altered or revised by **Shanghai Global Testing Services Co., Ltd.** personnel only, and shall be noted in the revision section of the document.

3.2 Conducted disturbance at telecommunication ports

3.2.1 Test Equipment List and Details

Item	Test Equipment	Manufacturer	Model No.	Serial No.	Cal. Date	Cal. Due date
1	EMI test receiver	Rohde & Schwarz	ESCS25	1005426	2017-12-03	2018-12-02
2	Line impedance stabilization network	SCHWARZBECK	NSLK838	8127-350	2017-12-03	2018-12-02

3.2.2 Description of Measurement Conditions

Temperature: 20°C

Humidity: 60%

Pressure: 1033mbar

Electromagnetic environment: normal

3.2.3 Limits for conducted disturbance at the mains terminal of class B ITE.

Frequency range MHz	Limit values dB(μV)	
	Quasi-peak	Average
0.15 to 0.5	84~74	74~64
0.5 to 30	74	64

NOTE 1: The lower limit shall apply at the transition frequencies.
NOTE 2: The limit decreases linearly with the frequency in the range 0,15 MHz to 0,50 MHz.

3.2.4 Configuration

The configuration is in accordance with the requirement in EN 55022

3.2.5 Test Data and Records

Test case does not apply to the test object

3.2.6 Verdict

The EUT met the requirement.

3.3 Radiation Disturbances

3.3.1 Test Equipment List and Details

Item	Test Equipment	Manufacturer	Model No.	Serial No.	Cal. Date	Cal. Due date
1	EMI test receiver	Rohde & Schwarz	ESU40	100987	2017-12-03	2018-12-02
2	Antenna	SCHWARZBECK	VULB9168	9168-493	2017-12-03	2018-12-02
3	CONTROLLER	INNCO	CO200	722	/	/

3.3.2 Description of Measurement Conditions

Temperature: 20°C

Humidity: 60%

Pressure: 1033mbar

Electromagnetic environment: normal

3.3.3 Limits of radiated disturbances of class B ITE at a measuring distance of 3m.

Frequency range MHz	Quasi-peak limits(3m) dB(μV/m)
30 to 230	40
230 to 1000	47
NOTE: The lower limit shall apply at the transition frequency.	
NOTE: Additional provisions may be required for cases where interference occurs.	

3.3.4 Test procedure and the test set-up

Procedure

- The EUT was placed on the top of a rotating table 0.8 meters above the ground at a 3m semi/full-anechoic chamber. The table was rotated 360 degrees to determine the position of the highest radiation.
- The EUT was set 3 meters away from the interference-receiving antenna, which was mounted on the top of a variable-height antenna tower.
- The antenna is a broadband antenna, and its height is varied from one meter to four meters above the ground to determine the maximum value of the field strength. Both horizontal and vertical polarization of the antenna are set to make the measurement.
- For each suspected emission, the EUT was arranged to its worst case and then the antenna was tuned to heights from 1 meter to 4 meters and the turn table was turned from 0 degrees to 360 degrees to find the maximum reading.
- The test-receiver system was set to Peak Detect Function and Specified Bandwidth with Maximum Hold Mode.
- If the emission level of the EUT in peak mode was 10 dB lower than the limit specified, then testing could be stopped and the peak values of the EUT would be reported. Otherwise the emissions that did not have 10 dB margin would be retested one by one using the quasi- peak method or average method as specified and then reported In Data sheet peak mode and QP mode.

Note: This report shall not be reproduced except in full, without the written approval of **Shanghai Global Testing Services Co., Ltd.** This document may be altered or revised by **Shanghai Global Testing Services Co., Ltd.** personnel only, and shall be noted in the revision section of the document.

Set-up

The configuration is in accordance with the requirement in EN 55022, the sketch map as follow:

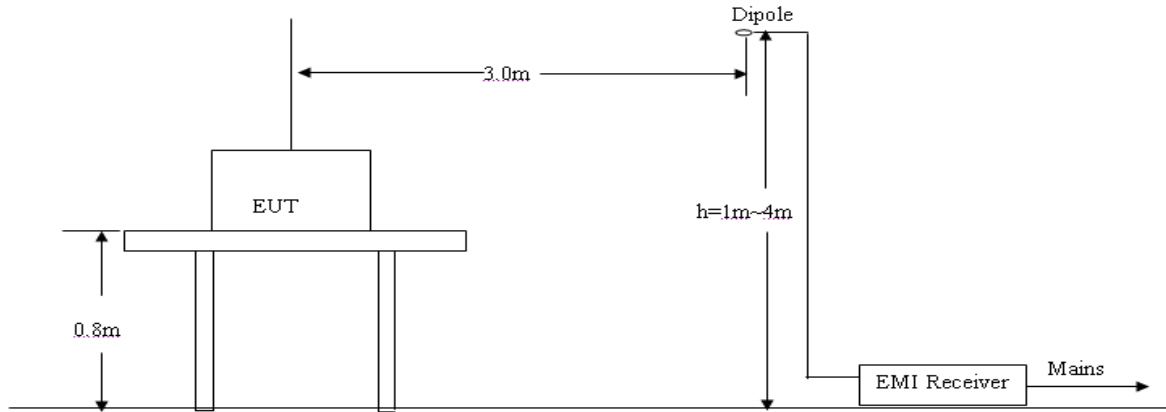

3.3.5 Test Data and Records

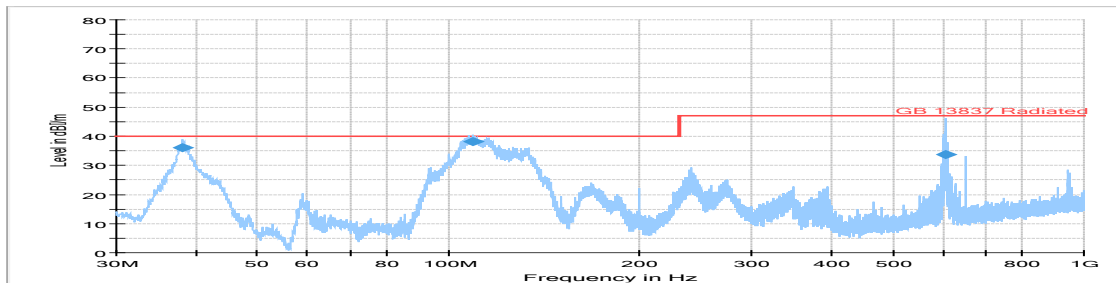
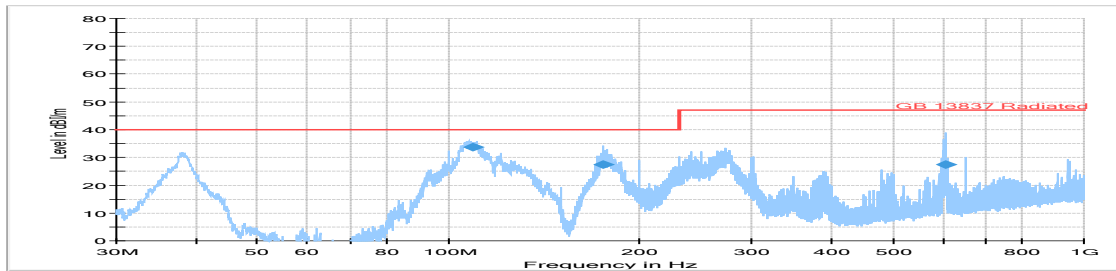

3.3.6 Verdict

The EUT met the requirement.

Note: This report shall not be reproduced except in full, without the written approval of **Shanghai Global Testing Services Co., Ltd.** This document may be altered or revised by **Shanghai Global Testing Services Co., Ltd.** personnel only, and shall be noted in the revision section of the document.

4 –EN55035

Description of Performance Criterion (According with CISPR 35 Section 8)

Performance Criterion A

The equipment shall continue to operate as intended without operator intervention. No degradation of performance or loss of function is allowed below a performance level specified by the manufacturer when the equipment is used as intended. The performance level may be replaced by a permissible loss of performance. If the minimum performance level or the permissible performance loss is not specified by the manufacturer, then either of these may be derived from the product description and documentation, and by what the user reasonably expects from the equipment if used as intended.

Performance Criterion B

After the test, the equipment shall continue to operate as intended without operator intervention. No degradation of performance or loss of function is allowed, after the application of the phenomena below a performance level specified by the manufacturer, when the equipment is used as intended. The performance level may be replaced by a permissible loss of performance.

During the test, degradation of performance is allowed. However, no change of operating state or stored data is allowed to persist after the test.

If the minimum performance level (or the permissible performance loss) is not specified by the manufacturer, then either of these may be derived from the product description and documentation, and by what the user may reasonably expect from the equipment if used as intended.

Performance Criterion C

Loss of function is allowed, provided the function is self-recoverable, or restored by the operation of the controls by the user in accordance with the manufacturer's instructions.

Function and/or information stored in non-volatile memory, or protected by a battery backup, shall not be lost

4.1 SURGES

4.1.1 Test Equipment List and Details

Item	Test Equipment	Manufacturer	Model No.	Series No.	Cal. Date	Cal. date Due
1	Ultra-compact simulator	EM test	UCS500M4	V050710012 2	2017-12-08	2018-12-07

4.1.2 Description of Measurement Conditions

Temperature: 21 °C
 Humidity: 58%
 Pressure: 1033mbar
 Electromagnetic environment: normal

4.1.3 Configuration

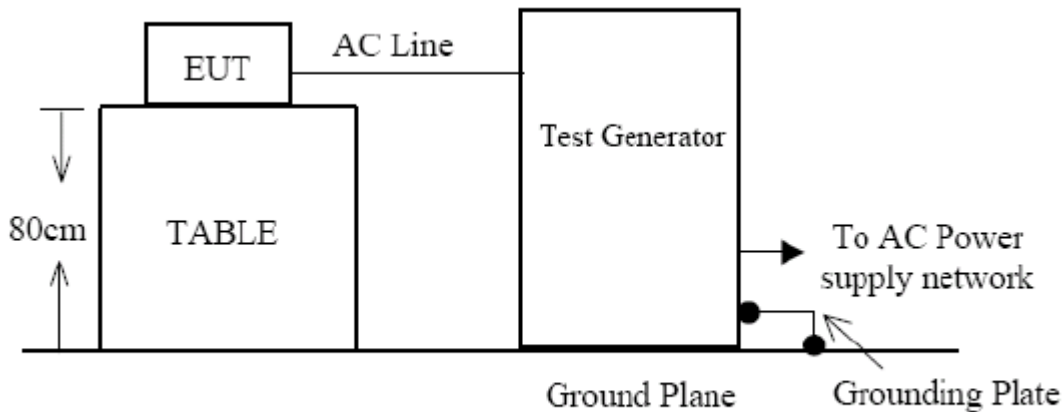

Remark: Test generator includes control center 、surge combination and coupler.

4.1.4 Test Data and Records

Level	Voltage	Poll	Phase angle	Path	Pass	Fail
1	1.0kV	±	0°, 90°, 180°, 270°	L-N	B	
2	2.0kV	±	0°, 90°, 180°, 270°	L-N	B	

4.1.5 Verdict

The EUT was working as normal, so they met the requirement of performance criteria B.

4.2 ESD

4.2.1 Test Equipment List and Details

Item	Test Equipment	Manufacturer	Model No.	Series No.	Cal. Date	Cal. date	Due
1	Electrostatic Discharge Simulator	KIKUSUI	KES4021	LL004798	201712-25	2018-12-24	

4.2.2 Description of Measurement Conditions

Temperature: 21 °C
 Humidity: 58%
 Pressure: 1033mbar
 Electromagnetic environment: normal

4.2.3 Configuration

The configuration is in accordance with the requirement in EN61000-4-2, see the photo in appendix.

4.2.4 Test Data and Records

Air Discharge

Test Levels																
EN61000-4-2 Test Points	-2 kV	+2 kV	-4 kV	+4 kV	-6 kV	+6 kV	-8 kV	+8 kV	-10 kV	+10 kV	-12.5 kV	+12.5 kV	-15 kV	+15 kV	-20 kV	+20 kV
EUT Front Side	B	B	B	B	B	B	B	B								
EUT Top Side	B	B	B	B	B	B	B	B								
EUT Back Side	B	B	B	B	B	B	B	B								
EUT Left Side	B	B	B	B	B	B	B	B								
EUT Right Side	B	B	B	B	B	B	B	B								

Note: This report shall not be reproduced except in full, without the written approval of **Shanghai Global Testing Services Co., Ltd.** This document may be altered or revised by **Shanghai Global Testing Services Co., Ltd.** personnel only, and shall be noted in the revision section of the document.

Direct Contact

Test Levels																
EN61000-4-2 Test Points	-2 kV	+2 kV	-4 kV	+4 kV	-6 kV	+6 kV	-8 kV	+8 kV	-10 kV	+10 kV	-12.5 kV	+12.5 kV	-15 kV	+15 kV	-20 kV	+20 kV
EUT Front Side	B	B	B	B												
EUT Top Side	B	B	B	B												
EUT Back Side	B	B	B	B												
EUT Left Side	B	B	B	B												
EUT Right Side	B	B	B	B												

4.2.5 Verdict

The EUT was working as normal, so they met the requirement of performance criteria B.

4.3 EFT/B

4.3.1 Test Equipment List and Details

Item	Test Equipment	Manufacturer	Model No.	Series No.	Cal. Date	Cal. date	Due
1	Ultra-compact simulator	EM test	UCS500M4	V050710012 2	2017-11-04	2018-11-03	

4.3.2 Description of Measurement Conditions

Temperature: 21 °C
 Humidity: 58%
 Pressure: 1033mbar
 Electromagnetic environment: normal

4.3.3 Configuration

The configuration is in accordance with the requirement in EN61000-4-4, see the photo in appendix.

4.3.4 Test Data and Records

Test Levels (kV)									
EN61000-4-4 Test Points		+0.25	-0.25	+0.5	-0.5	+1.0	-1.0	+2.0	-2.0
Power Port of EUT	L	B	B	B	B	B	B		
	N	B	B	B	B	B	B		
	L+N	B	B	B	B	B	B		

4.3.5 Verdict

The EUT was working as normal, so they met the requirement of performance criteria B.

4.4 Radio-frequency continuous conducted, 0.15 MHz to 80 MHz

4.4.1 Test Equipment List and Details

Item	Test Equipment	Manufacturer	Model No.	Series No.	Cal. Date	Cal.Due date
1	AM/FM signal generator	AEROFLEX	2023A	202306/668	2017-12-03	2018-12-02
2	PAMP Conducted RF test system	HAEFFLY	PAMP250	151730	2017-12-03	2018-12-02
3	CDN impedance and K-factor	LUTHI	L-801 M2/M3	9931	/	/

4.4.2 Description of Measurement Conditions

Temperature: 22°C
 Humidity: 59%
 Pressure: 1033mbar
 Electromagnetic environment: normal

4.4.3 Configuration

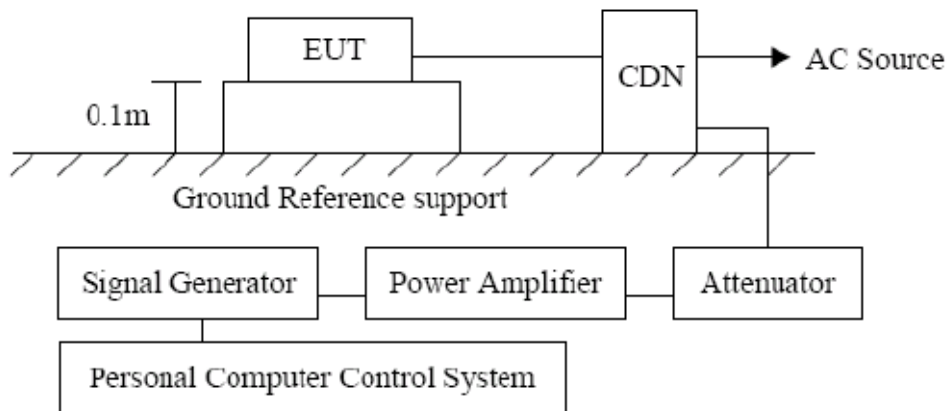

4.4.4 Test Data and Records

EN61000-4-6 Test Points	Frequency range MHz	Levels	Voltage Level (e.m.f.)V	Pass	Fail
Power Line	0.15-80MHz	1	1		
		2	3	A	
		3	10		
		X	Special		

4.4.5 Verdict

The EUT was working as normal, so they met the requirement of performance criteria A.

Note: This report shall not be reproduced except in full, without the written approval of **Shanghai Global Testing Services Co., Ltd.** This document may be altered or revised by **Shanghai Global Testing Services Co., Ltd.** personnel only, and shall be noted in the revision section of the document.

4.5 VOLTAGE DIPS AND INTERRUPTIONS

4.5.1 Test Equipment List and Details

Item	Test Equipment	Manufacturer	Model No.	Series No.	Cal. Date	Cal. date Due
1	Ultra-compact simulator	EM test	UCS500M4	V0507100789	2017-06-08	2018-06-07
2	Motorised Variac	EM test	MV2616	V0507100459	2017-06-08	2018-06-07

4.5.2 Description of Measurement Conditions

Temperature: 21 °C
 Humidity: 58%
 Pressure: 1033mbar
 Electromagnetic environment: normal

4.5.3 Configuration

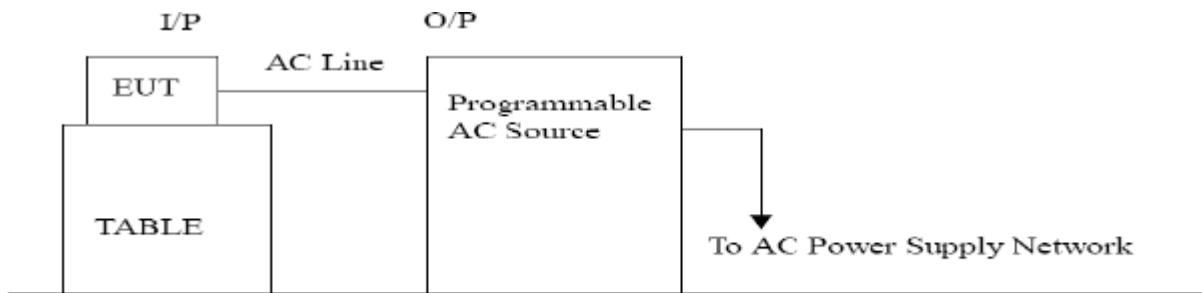

4.5.4 Test Data and Records

Environmental phenomena		Test level in % U_T	Duration (in periods of the rated frequency)	Phase Angle	Pass	Fail
Interruptions	>95	<5	250T	0/180	C	
Voltage dips in % U_T	>95	<5	0.5T	0/180	B	

4.5.5 Verdict

The EUT was working as normal, so they met the requirement of performance criteria C.

4.6 Radio-frequency electromagnetic field

4.6.1 Test Equipment List and Details

Item	Test Equipment	Manufacturer	Model No.	Serial No.	Cal. Date	Cal. Due date
1	Ultra broadband antenna	Rohde & Schwarz	HL562	100944	2017-12-8	2018-12-7
2	amplifier	AR	30W1000B	0327284	--	--
3	amplifier	AR	30S1G3	0324978	--	--
4	power meter	Rohde & Schwarz	NRP	101641	2017-12-05	2018-12-04
5	Signal generator	Rohde & Schwarz	SMR40	100657	2017-06-08	2018-06-07

4.6.2 Description of Measurement Conditions

Temperature: 20°C
 Humidity: 60%
 Pressure: 1033mbar
 Electromagnetic environment: normal

4.6.3 Configuration

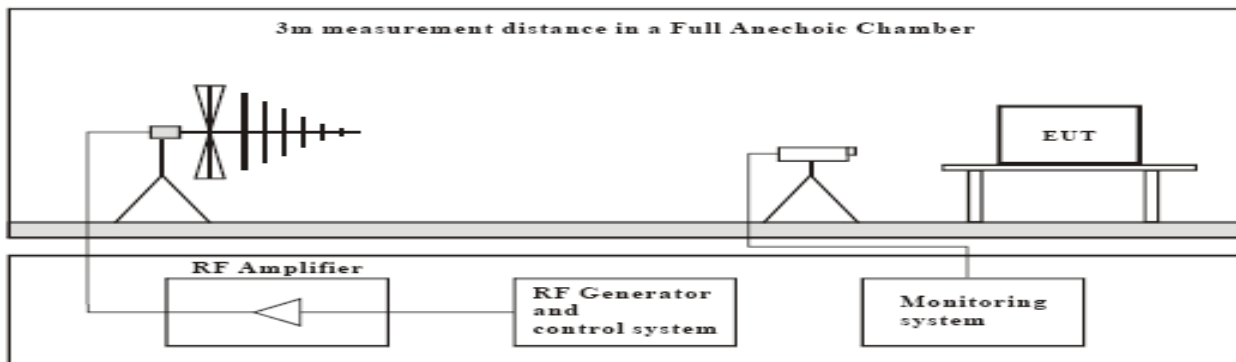

4.6.4 Test Data and Records

Frequency Range (MHz)	Front Side (3 V/m)		Rear Side (3 V/m)		Left Side (3 V/m)		Right Side (3 V/m)	
	VERT	HORI	VERT	HORI	VERT	HORI	VERT	HORI
80-1000	A	A	A	A	A	A	A	A

4.6.5 Verdict

The EUT was working as normal, so it met the requirement of performance criteria A.

Note: This report shall not be reproduced except in full, without the written approval of **Shanghai Global Testing Services Co., Ltd.** This document may be altered or revised by **Shanghai Global Testing Services Co., Ltd.** personnel only, and shall be noted in the revision section of the document.

4.7 Power-frequency magnetic field

4.7.1 Test Equipment List and Details

Item	Test Equipment	Manufacturer	Model No.	Serial No.	Cal. Date	Cal. Due date
1	Magnetic field tester	HAEFELY TEST AG	MGA 100	152676	2017-12-8	2018-12-7
2	Active loop	EMCO	6502	9003-2484	2017-12-8	2018-12-7

4.7.2 Description of Measurement Conditions

Temperature: 22°C
 Humidity: 59%
 Pressure: 1033mbar
 Electromagnetic environment: normal

4.7.3 Configuration

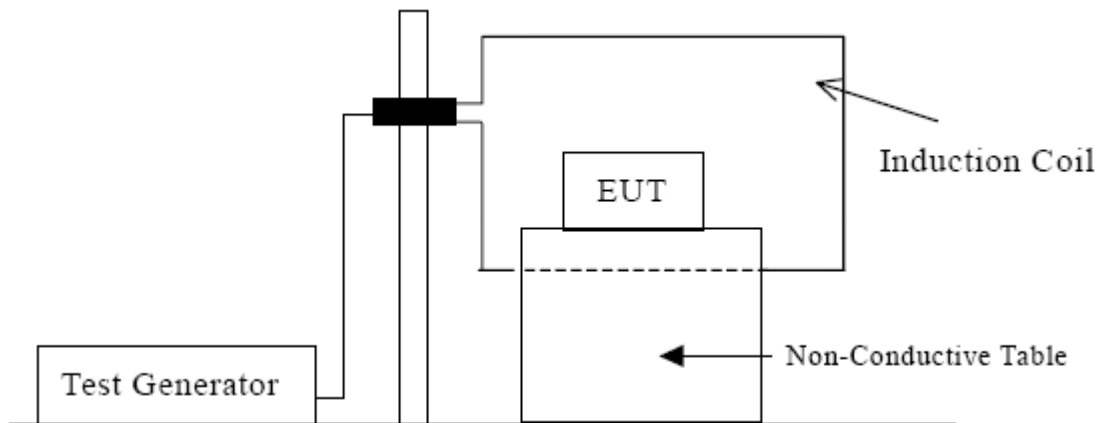

4.7.3 Test Data and Records

Power Frequency Magnetic Field	Testing Duration	Coil Orientation	Pass
50Hz, 60 Hz 3 A/m	1 Min	X-axis	A
50Hz, 60 Hz 3 A/m	1 Min	Y-axis	A
50Hz, 60 Hz 3 A/m	1 Min	Z-axis	A

4.7.4 Verdict

The EUT was working as normal, so it met the requirement of performance criteria A.

Note: This report shall not be reproduced except in full, without the written approval of **Shanghai Global Testing Services Co., Ltd.** This document may be altered or revised by **Shanghai Global Testing Services Co., Ltd.** personnel only, and shall be noted in the revision section of the document.

APPENDIX —PHOTOGRAPH

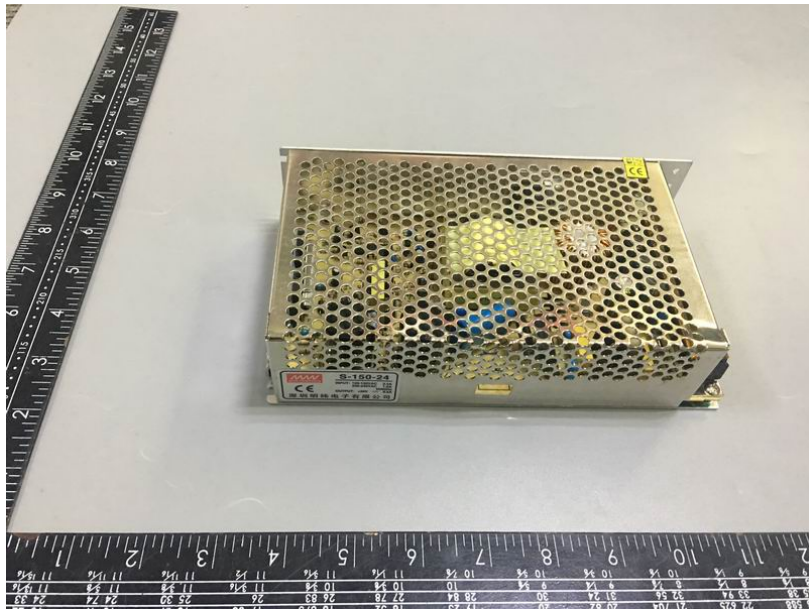
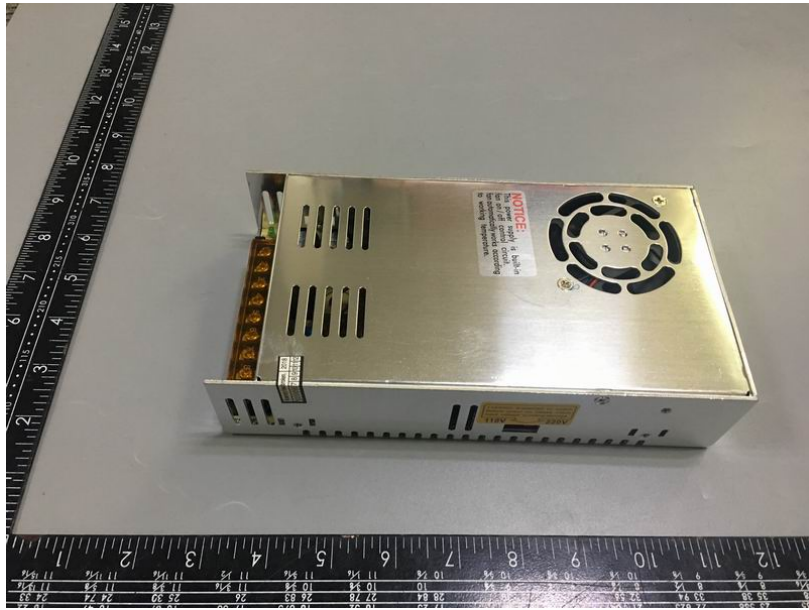

Note: This report shall not be reproduced except in full, without the written approval of **Shanghai Global Testing Services Co., Ltd.** This document may be altered or revised by **Shanghai Global Testing Services Co., Ltd.** personnel only, and shall be noted in the revision section of the document.

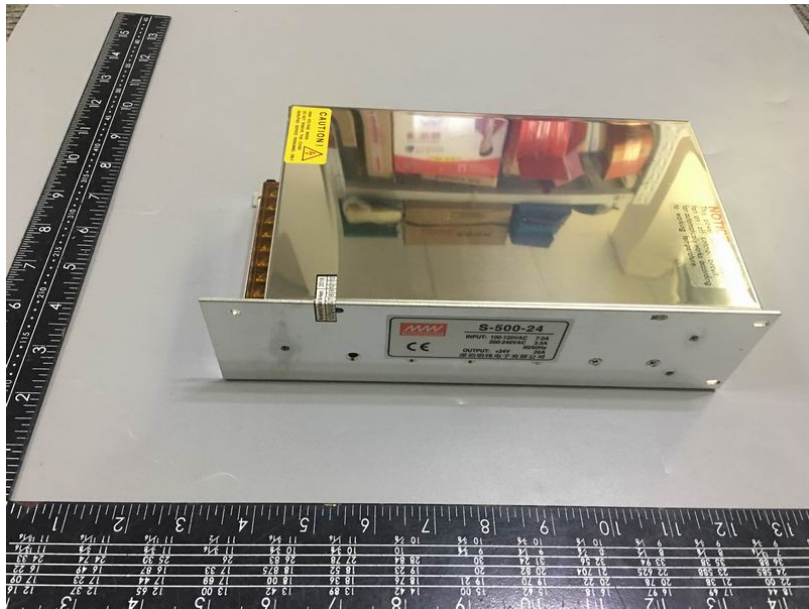

--- End of Test Report ---

Note: This report shall not be reproduced except in full, without the written approval of **Shanghai Global Testing Services Co., Ltd.** This document may be altered or revised by **Shanghai Global Testing Services Co., Ltd.** personnel only, and shall be noted in the revision section of the document.